

Revision Notes

R1 - RADIUS INCORRECTLY DIMENSIONED ON SUNSHIELD CORRECTED.				
APPA: WENHENG QIN	Drawn: MBUTLER	Checked: RBATES	Approved: B.JOHN	Date: 03/04/14

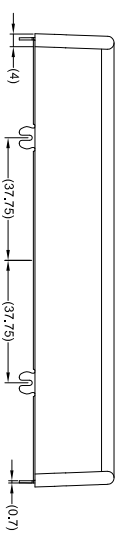
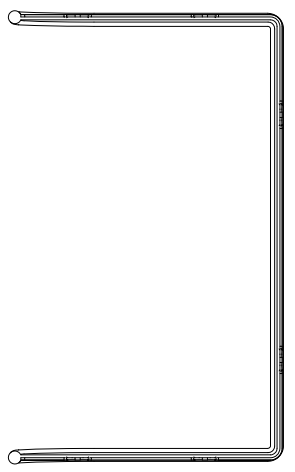
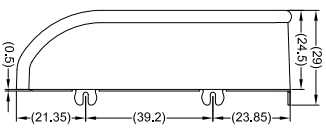
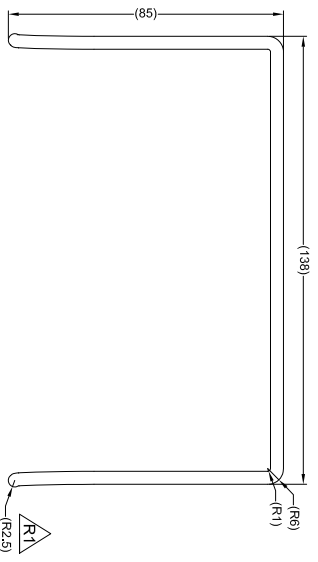
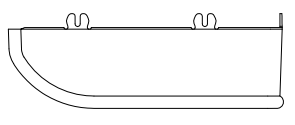
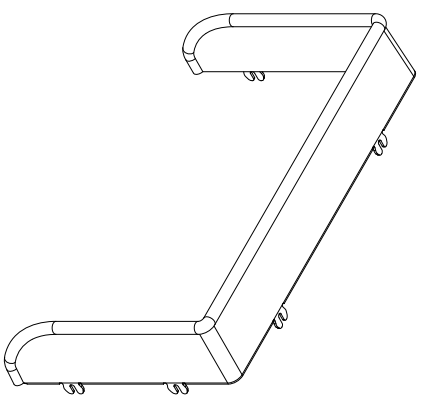

- NOTES:**
1. FINISH: TEXTURED, MATT BLACK.
 2. MATERIAL: ABS-757.

PROPRIETARY NOTICE
 THIS DESIGN AND TECHNICAL INFORMATION APPEARING ON THIS DRAWING IS THE PROPERTY OF BRIGADE ELECTRONICS, AND IS DISCLOSED IN CONFIDENCE. IT IS NOT TO BE COPIED, REPRODUCED, REVEALED TO OR EXPLOITED BY OTHERS, EITHER IN WHOLE OR IN PART WITHOUT THE EXPRESS WRITTEN CONSENT OF BRIGADE ELECTRONICS.

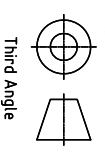

Assembly PI Approval DONGQING LIN (20/01/14)		Approved by B.JOHN		Checked by RBATES		Drawn by MBUTLER	
Angle of Projection	Units mm	Scale N/A	Released 20/01/14	Assembly Ref 32020000074	Status RELEASED	Part No 4523	

VBV-770M-SS	
BE-002625-01-13	